

LEADER FOX



Electric Bicycle Operating Instructions

Under the law, the dealer is obliged to attach the LEADER FOX Electric Bicycle Operating Instructions to every product



E – BIKE POWER RIDE

Forenza



Introduction

Dear users,

Please read carefully all the information regarding your E-LF product to ensure optimal functioning of your e-bike. The following text containing a comprehensive description will provide you with information on all aspects and details (including installation, setting up and general use of the display) regarding the use of our display. This instruction document will also help you solve potential problems and failures.

What is an electric bicycle?

Electric bicycle is a conventional bicycle with an electric drive added to assist the rider. The motor function is actuated by pedalling, which is scanned by a special sensor installed in the pedal hub. Therefore, you have to keep pedalling on an e-bike, the motor is there only to help you. You can set an electric bicycle in motion also using a control button or an accelerator but only up to the maximum permitted speed of 6 KMPH (e.g. for walk assistance). The maximum speed of an e-bike with motor assistance is 25 KMPH, with a 10% tolerance (when this speed limit is reached, the motor switches off and you need to pedal just like with a regular bicycle). When your battery runs out of power or your motor is off, you can ride your electric bicycle as a conventional bike, without any resistance at all.

From the point of view of the Road Traffic Act, an electric bicycle whose features conform to European standard EN 15194-1 is regarded as a regular bicycle, i.e. you can ride on bike trails, do not need a driver's license and a helmet is mandatory only up to 18 years of age.

Description



Factors influencing the electric bicycle range

- 1. Rolling resistance of the tyres.** Leader Fox e-bikes are fitted with tyres with low rolling resistance and increased resistance to puncture. It is also important that the tyres are inflated properly. Therefore, if the tyres of your electric bicycle are underinflated, the range will decrease.
- 2. Weight of the electric bicycle.** The lower weight of the electric bicycle, the greater the range.
- 3. Battery status.** It depends on whether the battery was fully charged before your trip. It is also to be expected that the higher the number of discharge cycles the battery has undergone, the smaller capacity it has.
- 4. Profile and surface of the track.** The higher the elevation difference and the steeper hills you negotiate and the worse surface, the shorter the range.
- 5. Riding mode.** It depends on which of the three riding modes you have set.
- 6. Continuity of riding.** The more braking and acceleration, the shorter the range.
- 7. Air resistance.** For example, it depends on whether we ride a bicycle with low frame and sitting upright or whether we ride sporty bicycle with seat set to the same height as the handlebars.
- 8. Wind strength.** The stronger the wind we have back, the longer the range and vice versa.
- 9. Weight of the rider and load.** The greater the weight, the shorter the range.
- 10. External temperature.** The lower the temperature, the less battery capacity can be used while riding.

Safety instruction

Battery:

- Do not throw the battery into fire.
- Do not throw the battery into water.
- Do not use the battery for other appliances. It has been made specifically for this model.
- Do not dismantle or modify the battery.
- Do not connect the positive and negative poles of the battery.

Charger:

- Do not dismantle or modify the charger.
- Do not use the charger for other appliances. It has been made specifically for this model.
- Do not throw the charger into fire or water.
- Do not touch the charger with wet hands.
- Keep the charger from animals or children.
- Do not cover the charger.
- Do not use the charger if it is broken.

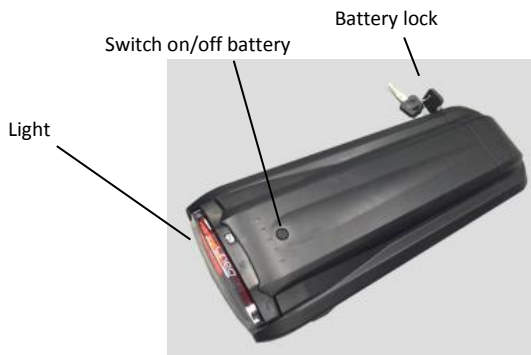

Charging set



Battery

Battery charging and maintenance:

Charge the battery in a dry environment to avoid short-circuit damage.

Charge the battery to at least 60% of the capacity once every 3 months even when the bicycle is not used.

Do not cover the battery or the charger.

Do not leave the battery constantly connected to the power source.

Do not use the battery for other appliances. It has been made specifically for this model.

Do not disassemble or modify the battery pack.

Do not throw the battery into fire or expose it to extreme temperatures.

Recharging time from zero to 100% is 1-7 hours.

Drive warranty:

The warranty applies to those drive parts that are not sensitive to improper handling (pack, electronics, charger, etc.); such parts are covered by a 24-month warranty.

The warranty does not apply to chemical parts of the battery and to capacity reduction due to normal use (39% after the expiry of two years); those parts are covered by a 12-month warranty.

Charging:

The battery is the most expensive part of an electric bicycle; therefore, pay increased attention during handling, charging and storage. The battery is sensitive to precise charging. Therefore, it is necessary to charge Li-Ion rechargeable batteries using only a charger supplied by us. Connect the charger to 220-240 V power outlet. 5A protected circuit is sufficient. The charger will automatically suspend charging when full capacity of all cells is reached.

We recommend discharging the battery in full after each ride to ensure that your battery will be up to its full capacity for your next ride. Charging the battery may last 1 to 5 hours depending on the condition of the battery cells. Charge it exclusively in covered dry areas (moisture and dripping water can damage the charger) at a temperature of 5 to 40°C.

The charging process is indicated by a red glowing LED. It will turn green when the battery is charged and the charging process is complete. The battery contains a charge-monitoring indicator (when the charge indicator button is pressed, the light indicator will come on). Always switch off the battery when finished riding the bike.

Normal battery behaviour:

If the motor stops running smoothly and switches to intermittent operation, it could be a sign of low battery capacity. In that case switch off the electric drive system and continue without motor assistance, as if riding a conventional bicycle.

Battery warming is normal and does not indicate any defect. The battery is protected by a temperature sensor and switches off automatically in case of excessive overheating. Wait until the battery cools down to its normal operating temperature and then ride on.

If you feel your total battery capacity has dropped, it could be caused by charging or operation in suboptimal climatic conditions. Carry out 3 full charging cycles. Fully discharge the battery while riding and then charge to its full capacity at room temperature.

If the charge indicator shows that the battery is discharged, there is still a minimum voltage level in it which protects it against damage but is not enough to power the electric bicycle. Recharge the battery as soon as possible. Never leave the battery fully discharged, it could result in its damage.

If you switch on the battery by POWER button the rear light will switch on too. The light is on from safety point whole the time. If you want to switch off it, you have to switch off whole bike by POWER button on the top side of the battery.

In the case, that the battery will be turned on more than 30 min and bike will not be used, the battery will be automatically switched off.

Proper care of the battery prolongs its life.

LCD display



Product:

Intelligent LCD display APT TFT750C

Supplier:

Tianjin APT Development Cop., Ltd.

Electrical parameters:

Battery supply 36V

Rated operating current 40mA

Max operating current 100 mA

Off leakage current < 1 uA

Max output current to controller 150mA

Operating temperature -20 ~ 70 °C

Storage temperature -20 ~ 70 °C

Dimensions and materials:

High-contrast TFT colorful display.

Product shell is ABS, transparent window is made with high strength Acrylic.

Can be used up to -20°C.

CE / IP65 water proof / ROHS.

TFT screen instruction:

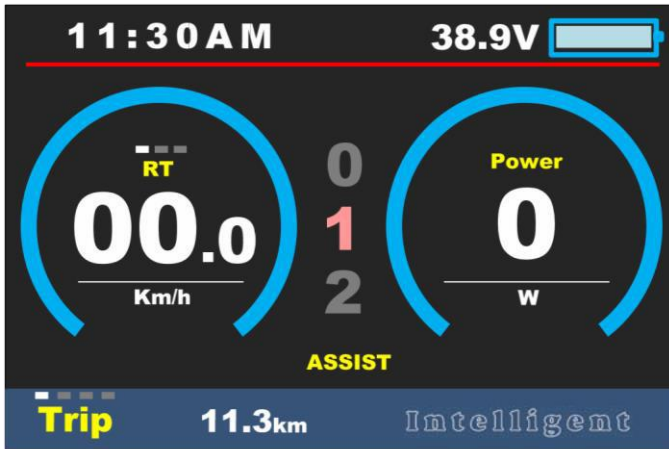

RT Speed –indicator of speed mode(RT, MAX, AVG)

00.0 –speed

Km/h –indicator of speed unit

Power 0W –performance

11:48 PM –time

39.8V –battery capacity

1 assist –level PAS, 0 (off)5 (max. assist)

Trip –indicator of mileage mode

0.3 km –distance

Maximal range:

Maximal range is set with fully charge battery and flat terrain and little bit of headwind. Average range is calculated with ideal set of the assist and slightly hilly terrain.

Controller

Controller description:

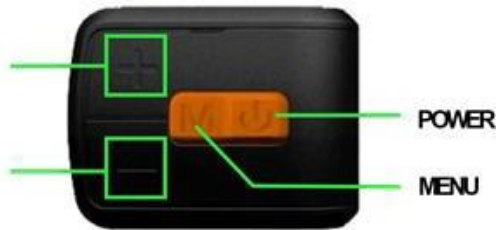

+ – up

-- down

 – power ON/OFF

M – menu

Assembly instructions

Display assembly:

Please pay attention to the tightening torque of screws. Damage caused by excessive tightening torque or incorrect assembly / disassembly is not covered by warranty.

When installing the display insert two rubber retaining rings into the display clamping jaws and put them onto handlebars. Use an Allen wrench to tighten the screws. Set your chosen display angle and tighten the screws. Tightening torque: 1 Nm

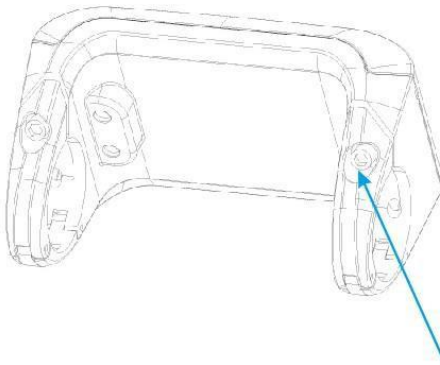

M4*10
STD=0.1N.M
MAX=0.2NM

Controller assembly:



M3*8
STD=0.25N.M
MAX=0.4N.M

A –controller clamping jaw

Open the controller clamping jaw and place it on handlebars in your chosen position. Use an Allen wrench to tighten the locking screw M3x8. Tightening torque: 1 Nm

Connector description:

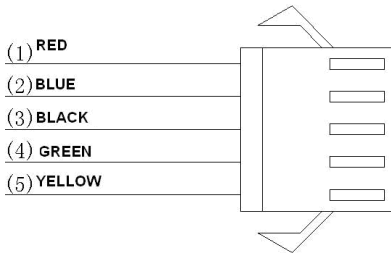

1 –Red wire: Anode (24V/36V)

2 –Blue wire: Power cord to the controller

3 –Black wire: GND

4 –Green wire: RxD (controller -display)

5 –Yellow wire: TxD (display -controller)

Control

Turning on the electrical system of the e-bike:

Before switch on of the system please check electrical wiring.

Switch on power of the electrical system on battery, colored backlighting illuminates.

Switch on display with press and short hold (1,5 second) POWER button. Display will automatically turns off if it is not used for a while. Can be set range 0 ~ 9 minutes (or OFF).

After ride turns off e-bike in the same way.

Press and hold UP button for turns on the display backlight.

For better gear change is appropriately stop pedaling for a while.

Assist level operating:

Short press UP/DOWN button can change the assist level. Top assist level is 5, 0 for neutral. After switch the assist from 0 it is possible, that the bike will not assist, please pedal one or two times backwards and the pedal sensor will be activated.

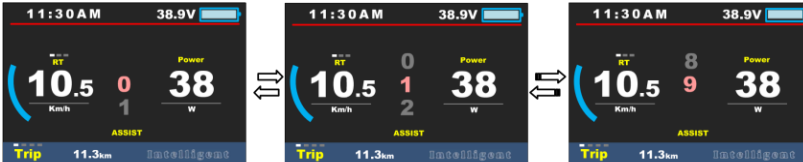

Walking mode:

Press and hold DOWN button for 2 second can get into walking mode, out of the mode when release the button.

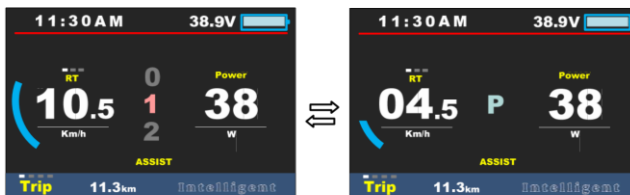

Headlight/Backlight On/Off:

Press and hold UP button for 1 second can turn on/off the headlight and the screen will switch to the corresponding mode.

The motor does not work when battery voltage is low. Display still can keep the headlight on for a while when e-bike is in riding.

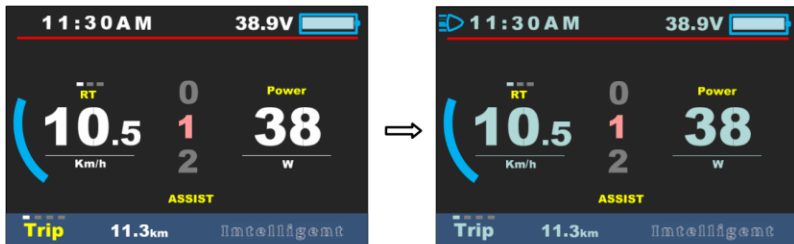

Daytime mode

night mode

Speed mode switch:

Short press Menu (M)button can change the speed and mileage mode –RT Speed->AVG Speed->MAX Speed

Mileage mode switch:

Short press POWER button can change the speed and mileage mode-Trip->ODO-> Time

Data cleanup:

Press and hold UP and DOWN button together for 1 second can reset several temporary data, temporary data include AVG speed/MAX speed/Trip/Time.

Parameter setting

By double press Menu (M) button (interval less than 0,3 second) can get into setting menus.

Press UP/DOWN buttons to change the parameter setting, press Menu (M) button to switch to next item.

Double press Menu (M) button will exit from menu.

Display will automatically quit menu when there is no operation for 30 seconds.

Press Power button for switch between Display setting and Basic setting.

For safety reasons, you can not enter the settings menu while riding.

System (Km/mile):

Press UP/DOWN button to switch between Metric/Imperial.

MENU	
Display Setting	Basic Setting
→ System	Imperial
Brightness	
Auto off	OFF
Scenes	Digital
Battery Ind	Voltage
Clock	>
16:25 EXIT	

Brightness:

Press UP/DOWN button to change the brightness of the backlight, I is darkness, ||||| is brightness.

MENU	
Display Setting	Basic Setting
→ System	Metric
Brightness	
Auto off	OFF
Scenes	Digital
Battery Ind	Voltage
Clock	>
EXIT	

↔

MENU	
Display Setting	Basic Setting
→ System	Metric
Brightness	
Auto off	OFF
Scenes	Digital
Battery Ind	Voltage
Clock	>
EXIT	

Auto Off:

Press UP/DOWN button to change the auto power off time, from 1 to 9 the number represent time (minutes) to shutdown, default value is 5 minutes.

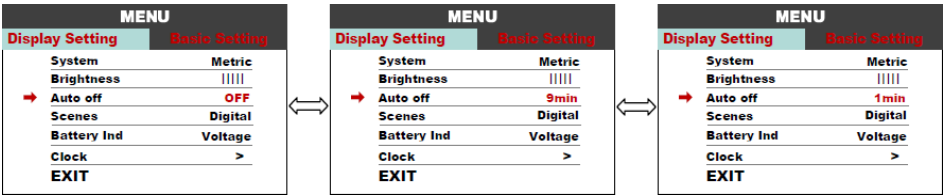

Scene:

Press UP/DOWN button to change the scenes, Digital/Analog.

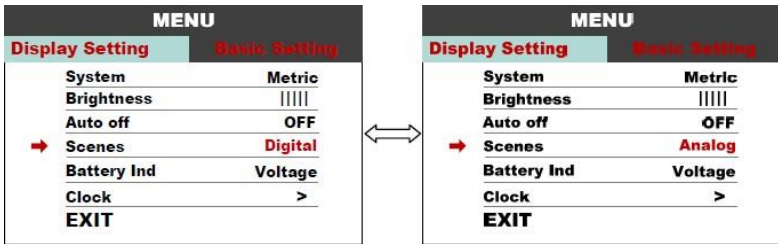

Battery Ind:

Press UP/DOWN button to change the battery indicator, Voltage/Percentage/Off.

Accurate percentage needs communication with battery.

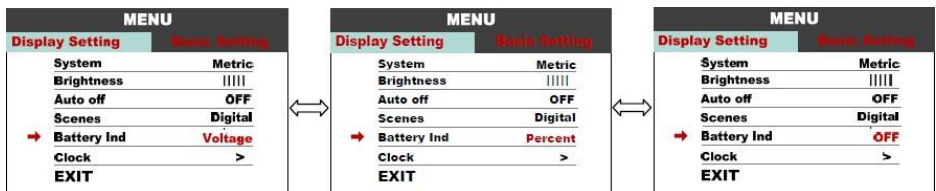

Clock:

Clock setting, press POWER button get into the clock setting menu, press UP/DOWN button to set Year/Month/Day/Hour/Min/Sec.

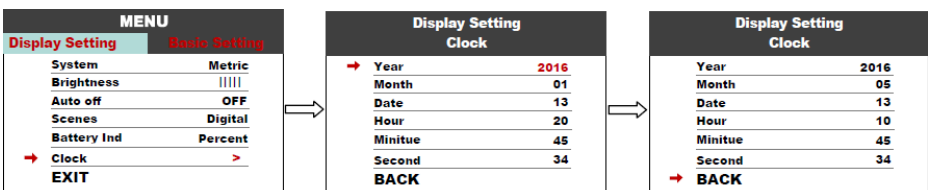

Basic setting:

**System is factory set. For changing these parameters contact your dealer or producer.
Do not change these parameters by yourself, you can damage the e-bike.**

Damaged caused by improper treatment is not within the scope of the warranty.

Maintenance

Regular maintenance:

- maintain all components of the electric bicycle clean
- use only the recommended and tested cleaning materials
- regularly lubricate the chain with suitable oils
- in winter, clean the electric bicycle after each ride and pay increased attention to removing salt from battery contacts and other connectors
- while handling the electric bicycle, make sure the cables of the electric system are not damaged. Damaged cables pose a risk of electric shock
- regularly check all connections for correct tightening and brakes for correct function. Check also individual parts of the electric bicycle for damage. For example: cracks on the frame, fork, handlebars, stem, damage to cables, damage to battery pack, etc.

Battery transport:

Battery transport is subject to the requirements of regulations on dangerous goods. Private users may transport undamaged batteries on roads without having to conform to other conditions.

In case of transport by commercial users or by third parties it is necessary to comply with special packaging and marking requirements (e.g. ADR regulations)

Batteries should only be sent if the battery pack is undamaged. Plug loose contacts and pack the battery to prevent its movement in the packaging. Notify the forwarding service that the transport concerns dangerous goods.

Battery storage:

Store the battery in a dry and well-ventilated place, out of reach of direct sunlight and other heat sources. In case of cold storage it is necessary to let the battery warm up to normal room temperature (20°C) before putting into operation.

Never leave the battery fully discharged. It could result in its permanent damage. For long-term storage keep the battery fully charged. However, do not store it while permanently connected to the charger or installed in the electric bicycle.

Li-Ion batteries are fully recyclable. After expiry of the battery life you can return it at any collection point or your dealer.

If you use an e-bike in hard conditions (long-term use of the maximum assistance), for longer ride at higher temperatures (30 ° C or above), in direct sunlight or when the battery is partially discharged and a combination of these situations is it possible that bike will automatically switch off. This is a fuse protecting the control unit against burning. We recommend stop the ride and let the bike (control unit) cool down little bit. This is not a defect.

Possible problems and their solutions

In case of system failure perform its diagnostics or contact your dealer.

The control LCD display is not on:

- always make sure the battery is charged
- check whether the battery is inserted correctly, whether the battery switch is on
- check the connections of the control unit and the display

The motor does not start when the walk assistance button is pressed

- check the connection of the motor cable (at the motor and the control unit)
- check the connections of the control unit and the display

The motor does not start when rotating the pedal cranks (pedalling)

- check the connection of the pedalling sensor to the control unit
- check the distance between the pedalling sensor and the magnet disk (max. 4 mm)
- check whether the disk is firmly attached to the central axle and does not spin freely
- in case of use of compact-type pedalling sensor

Warning

When there is a problem with the electric bicycle, it can show error messages. LCD display will show the icon and an error code will be displayed on the speed display. Error codes are marked from 01 E~FF E; see their meaning in the table below.

Error code	Description	Solution
1	Communication error	Check the cable connection
2	Regulator protection	Check the three-phase electric line
3	Three-phase supply error	Check the three-phase connection
4	Low battery	Charge the battery
5	Brake error	Check the brake connection
6	Turn error	Check the turn connection
7	Hall probe error	Check the hall probe connection

Assembly and disassembly of the wheel with the engine

For transportation and maintenance (replacing the tire tube) it may sometimes be necessary to disassemble the wheel with the engine.

First, pull lightly to disconnect the engine connector (about 20 cm from the engine entry).

Then loosen the brake (if it is used) and change the gear to the smallest wheel.

Remove the rubber covers from the wheel nuts.

Loosen the engine nut using a spanner size 18 and remove the wheel from the frame.

For assembly, reverse the order of these steps.

To connect the connector properly, the arrows on the connector (1) must face each other.

Switch the drive unit on and test it.

During wheel assembly, pay attention to the proper position of the central axis of the wheel nave facing down. The cable must enter the engine from below. Otherwise, water could get into the engine on the cable and the engine could be damaged.

Electric set warranty

Complaint procedure:

Submit any complaints concerning the electric set or the battery to your dealer.

When filing a complaint, submit a proof of purchase and a warranty certificate with the registered serial number of the battery and indicate the reason for the complaint and a description of the defect.

Warranty conditions:

24 months for electric bicycle components – applies to manufacturing and material defects beyond normal wear and tear caused by use.

12 months for battery life – the nominal battery capacity does not drop below 70% of the total capacity over 12 months from the sale of the electric bicycle.

Warranty conditions:

The electric set must be used exclusively for the purposes it is intended for.

The electric set must be used, stored and maintained in accordance with these Operating Instructions.

A warranty claim shall expire:

If it is found out that the damage to the product is due to the user's fault (accident, inexpert handling beyond the framework of these Operating Instructions, tampering with the structure of the electric bicycle or connection of the electric system, improper storage, etc.).

Expiry of the warranty period.

The warranty only applies to the first owner

Warning

If you do not understand any of the points in these Operating Instructions, please contact the dealer for explanation. Please read the whole manual!

Do not lend the e-bike to persons not briefed in its use and operation. Complaints resulting from improper handling will not be accepted.

The LF Energy electric bicycle is not intended for use by children under 15 years of age. Likewise, the electric bicycle cannot be used by persons unable to pedal or handle it independently. The manufacturer is not to be held responsible for any potential injuries or damage to the bicycle!

Ideal weather conditions for using an electric bicycle are dry days, when the outdoor temperature is above 10°C. When used at lower temperatures, the battery discharges faster due to physical phenomena. Using the electric bicycle at temperatures below 0°C is not recommended.

Do not expose the bicycle to direct sunlight as it is fitted with a protective temperature sensor for the electric motor.

Never submerge the battery, the charger and other electric components in water or another liquid.

Never wash the electric bicycle in a pressure washer (WAP) and always remove the battery before washing

It is forbidden to tamper with the connections of the electric motor, the control unit and the battery. Violating this section may result in the warranty not being acknowledged or in irreversible damage to the electric bicycle.

DO NOT USE chargers and components other than the ones included with the electric bicycle.

We cannot be held responsible for damage caused by use of other non-approved goods

LEADER FOX



Enjoy many pleasant and safe kilometres on your new electric bicycle.

Your Leader Fox Team



**Czech brand of electric bicycles.
BOHEMIA BIKE**

Address

Na Pankráci 1724
14000 Praha 4 - Pankrác

Development, design and manufacturing

Okružní 697
České Budějovice 37004

Phone: 388 314 885
Email: info@leaderfox.cz

